

MODEL ZB110L1 VENTILATION FAN WITH LIGHT

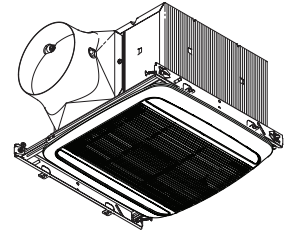

FEATURES

ULTRASMART™ DC Motor and Control Technology

- DC motor for efficiency well beyond ENERGY STAR® requirements.
- Multi-speed capability ideal for meeting ASHRAE 62.2, LEED and ENERGY STAR® for Homes requirements. Can be used to comply with CA Title 24, as well as local/spot ventilation needs.
- Powerful operation maintained over a wide range of real-world installations (CFM ratings maintained through at least 0.25" static pressure).
- Infinitely adjustable low cfm setting allows precise adjustment to prevent over-ventilating and maximize efficiency.
- Adjustable time delay sets how long fan will run on high speed before returning to a continuous lower speed.
- Rated for Continuous Operation.

ULTRASILENT™ Sound Technology

- HVI certified, best-achievable <0.3 Sone level provides nearly silent operation for a relaxing environment.
- State-of-the-art blower and duct outlet design smooths airflow.
- High tech DC motor designed for nearly silent operation.

ULTRALUCENT™ Lighting Technology

LIGHTING / GRILLE:

- Highly efficient, 18 Watt, integrated LED, dimmable
- LED lasts up to 25,000 hours
- Unique, low profile design for wide light pattern
- Even lens diffusion eliminates hotspots

TO OPERATE FAN AND LIGHT:

- Use only an ON/OFF or timer switch to operate the fan.
- Use only an ON/OFF switch, timer switch or relay-switch to operate the LED light.
- The LED light can be used with some dimmable switches (see below).
- Both the fan and LED light can be put on one switch.

DIMMING CONTROLS :

- May not be compatible with all dimmer controls
- Each application is unique and various factors such as load, common neutrals or other electrical products on the circuit can, in certain instances, cause variance in system performance.
- Dimmer model numbers vary slightly depending on color, packaging type, etc. such that variations of Model numbers may be suitable. Consult dimming system manufacturer for additional support in operation

* For a list of compatible controls, see broan.com.

ULTRAQUICK™ Installation Technology

- Unique telescoping mounting frame fits through retrofit drywall opening to allow easy installation from the room side. No attic access needed!
- Captive screws allow for easy new construction installation.
- Mounting frame positioning tabs provide easy vertical positioning for new construction.
- Easy to insert and remove snap-in housing. No screws required!
- Easy to insert and remove snap-in blower.
- Inside or outside duct connector and knockout plate mounting provides flexibility for new construction or retrofit.

U.L. Listed for use over bathtubs and showers when connected to a GFCI protected branch circuit (ceiling mount only).

U.L. Listed for use in insulated ceilings (Type IC).

Use only ON/OFF switch, mechanical timer or relay-switched control.

3-year warranty.

DIMENSIONS (Inches)

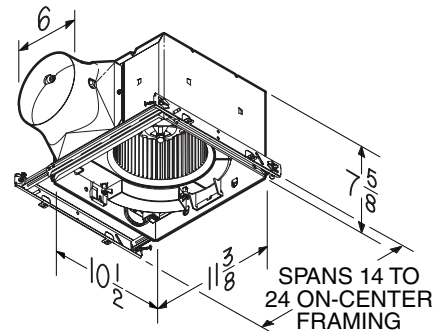

JA8-2019

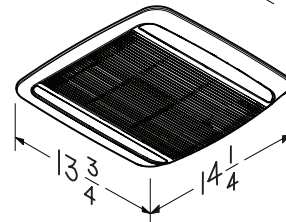

Broan Hartford, Wisconsin www.broan.com 800-558-1711

REFERENCE	QTY.	REMARKS	Project
			Location
			Architect
			Engineer
			Contractor
			Submitted by
			Date



PERFORMANCE SPECIFICATIONS

MODEL ZB110L1 VENTILATION FAN WITH LIGHT

AMCA LICENSED PERFORMANCE

Airflow Rate Setting (CFM)	Duct Size	Performance @ Static Pressure (Ps) - Inches Water Gage												Volts	Hz.	Nominal RPM	
		0.100" Ps			0.125" Ps		0.250" Ps		0.375" Ps		0.500" Ps		0.625" Ps				
		CFM	Sones	Watts	CFM	Sones	CFM	Sones	CFM	Sones	CFM	Sones	CFM				Sones
110	6" Round	110	0.3	9.3	110	0.4	110	1.1	93	1.9	57	2.6	22	3.4	120	60	980



Performance ratings include the effects of inlet grille and backdraft damper. Speed (RPM) shown is nominal. Performance is based on actual speed of test. The sound ratings are loudness values in fan sones at 5' (1.5m) in a spherical free field calculated per AMCA Std. 301. Values shown are for Installation Type B: free inlet hemispherical sone levels. Performance certified is for Installation Type B: Free inlet, Ducted outlet.

HVI PERFORMANCE

Airflow Rate Setting (CFM)	6" Duct				
	0.1 Ps - Static Pressure (inH2O)				0.25 Ps
	Airflow (CFM)	Sound (Sones)	Power (Watts)	Efficacy (CFM/Watt)	Airflow (CFM)
110	110	< 0.3	8.7	12.6	110
100	100	< 0.3	7.3	13.6	100
90	90	< 0.3	6.5	13.8	90
80	80	< 0.3	6.0	13.3	80
70	70	< 0.3	5.2	13.4	70
60	60	< 0.3	4.6	13.0	60
50	50	< 0.3	4.1	12.1	50
40	40	< 0.3	3.6	11.1	40
30	30	< 0.3	3.3	9.0	30



HVI-2100 CERTIFIED RATINGS comply with new testing technologies and procedures prescribed by the Home Ventilating Institute, for off-the-shelf products, as they are available to consumers. Product performance is rated at 0.1 in. static pressure, based on tests conducted in a state-of-the-art test laboratory. Sones are a measure of humanly-perceived loudness, based on laboratory measurements.

ELECTRICAL & WEIGHT

Volts	Hz	Amps*	Shipping Weight (lbs.)
120	60	0.5	13.7

* Total connected load



FAN CAPABILITY

